

1200mW Audio Power Amp with Shutdown

Features

- Operating voltage: 2.2V to 5.5V
- High signal-to-noise ratio
- Low distortion
- Large output voltage swing
- Low power consumption
- Output power 1200mW at 10% THD+N into 8Ω (V_{DD}=5V)
- Wide temperature operating range
- Low power-on and chip enable or disable POP noise.
- Low standby current
- Power off control
- Direct drive speaker
- 8-pin DIP/SOP package

Applications

- Applied for HT36 series, HT86 series and other Holtek products

General Description

HT82V739 is an integrated class AB mono speaker driver contained in a 8-pin DIP/SOP package. The HT82V739 is capable of delivering 1200mW output power to an 8Ω load with less than 10% (THD+N) from a

5V power supply. The very low standby current in shutdown mode contributes to the reduction of power consumption of battery-powered equipments.

Block Diagram

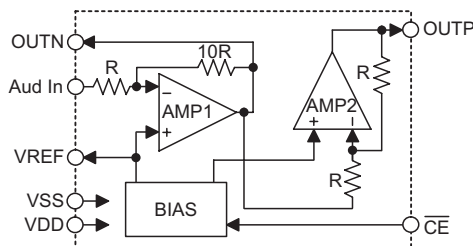

Pin Assignment

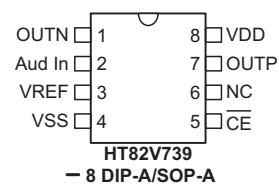

Pin Description

Pin No.	Pin Name	I/O	Description
1	OUTN	O	Negative output
2	Aud In	I	Audio input
3	VREF	O	Speaker non-inverting input voltage reference
4	VSS	—	Negative power supply, ground
5	CE	I	Chip enable, low active
6	NC	—	Not connected
7	OUTP	O	Positive output
8	VDD	—	Positive power supply

Absolute Maximum Ratings

Supply Voltage	$V_{SS}-0.3V$ to $V_{SS}+6.0V$	Storage Temperature	$-50^{\circ}C$ to $125^{\circ}C$
Input Voltage	$V_{SS}-0.3V$ to $V_{DD}+0.3V$	Operating Temperature	$-40^{\circ}C$ to $85^{\circ}C$

Note: These are stress ratings only. Stresses exceeding the range specified under "Absolute Maximum Ratings" may cause substantial damage to the device. Functional operation of this device at other conditions beyond those listed in the specification is not implied and prolonged exposure to extreme conditions may affect device reliability.

Electrical Characteristics
 $V_{SS}=0V, T_a=25^{\circ}C$

Symbol	Parameter	Test Conditions		Min.	Typ.	Max.	Unit	
		V_{DD}	Conditions					
D.C. Characteristics								
V_{DD}	Supply Voltage	—	—	2.2	5.0	5.5	V	
I_{DD}	Quiescent Power Supply Current	3V	$V_{IN}=0V_{P-P}$, No load	—	2.2	4.0	mA	
		5V		—	3.5	6.0	mA	
I_{SD}	Shutdown Power Supply Current	5V	$V_{IN}=0V_{P-P}$, $\overline{CE}=V_{DD}$, No load	—	—	1	μA	
V_{IH}	Input High Voltage for \overline{CE}	—	—	$0.7V_{DD}$	—	V_{DD}	V	
V_{IL}	Input Low Voltage for \overline{CE}	—	—	0	—	$0.3V_{DD}$	V	
P_o	Output Power	3V	(THD+N)/S \leq 1%, $V_{IN}=1kHz$ sinewave	$R_L=4\Omega$	198	330	—	mW
				$R_L=8\Omega$	180	300	—	
				$R_L=16\Omega$	144	240	—	
				$R_L=4\Omega$	270	450	—	
				$R_L=8\Omega$	240	400	—	
				$R_L=16\Omega$	168	280	—	
		5V	(THD+N)/S \leq 10%, $V_{IN}=1kHz$ sinewave	$R_L=4\Omega$	690	1150	—	mW
				$R_L=8\Omega$	570	950	—	
				$R_L=16\Omega$	390	650	—	
				$R_L=4\Omega$	840	1400	—	
				$R_L=8\Omega$	720	1200	—	
				$R_L=16\Omega$	480	800	—	
A.C. Characteristics								
t_{ON}	Enable Time	3V	$V_{IN}=1kHz$ sinewave, No load	—	145	—	μs	
		5V		—	105	—	μs	
(THD+N)/S	Total Harmonic Distortion Plus Noise-to-signal Ratio	5V	Power output=500mW, $V_{IN}=1kHz$ sinewave	$R_L=4\Omega$	—	0.3	—	%
				$R_L=8\Omega$	—	0.18	—	%
				$R_L=16\Omega$	—	0.13	—	%
S/N	Signal to Noise Ratio	5V	$V_{IN}=1V_{rms}$ 1kHz sinewave	$R_L=4\Omega$	—	66	—	dB
				$R_L=8\Omega$	—	70	—	dB
				$R_L=16\Omega$	—	72	—	dB

Functional Description

OUTP Rising Time (t_R)

When \overline{CE} is active low, the HT82V739 needs rising time to output fully on OUTP pin. However, the rising time depends on C1. (*see the application circuits)

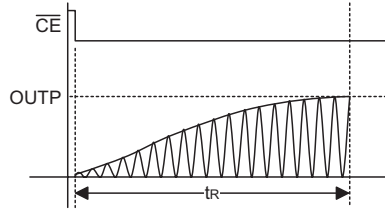

Voltage	Capacitor			
	t_R 0.1 μ F	1 μ F	4.7 μ F	10 μ F
2.2V	15ms	30ms	90ms	185ms
3V	15ms	30ms	90ms	185ms
4V	15ms	30ms	90ms	185ms

For battery based applications, power consumption is a key issue, therefore the amplifier should be turned off when in the standby state. In order to eliminate any speaker sound bursts while turning the amplifier on, the application circuit, which will incorporate a capacitance value of C1, should be adjusted in accordance with the speaker's audio frequency response. A greater value of C1 will improve the noise burst while turning on the amplifier. The recommended operation sequence is:

Turn On: "Aud In" signal standby (1/2 VDD) → enable amplifier → wait t_R for amplifier ready → "Aud In" signal start

Turn Off: "Aud In" signal finish → disable amplifier → wait t_R for amplifier off → "Aud In" signal off

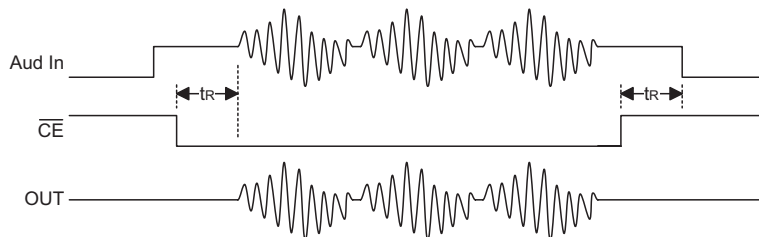

If the application is not powered by batteries and there is no problem with amplifier On/Off issue, a capacitor value of 0.1 μ F for C1 is recommended.

THD+N VS. Output Power

- $R_{LOAD}=4\Omega$, $V_{IN}=1\text{kHz}$ sinewave

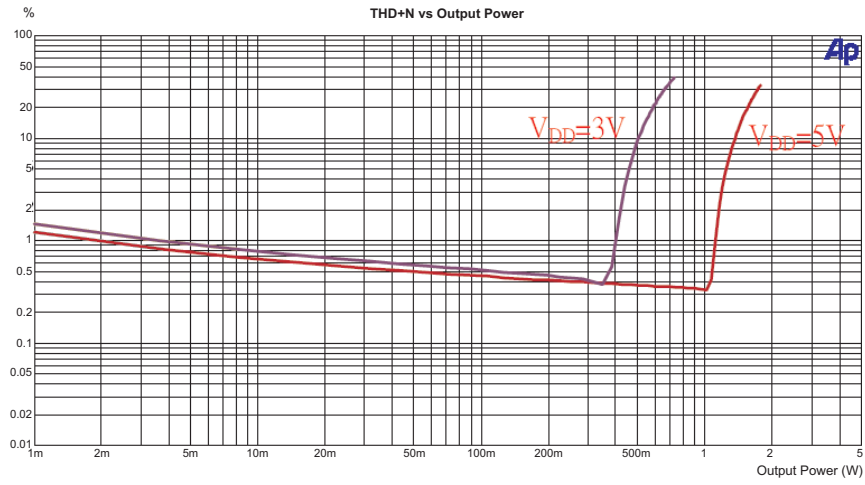

- $R_{LOAD}=8\Omega$, $V_{IN}=1\text{kHz}$ sinewave

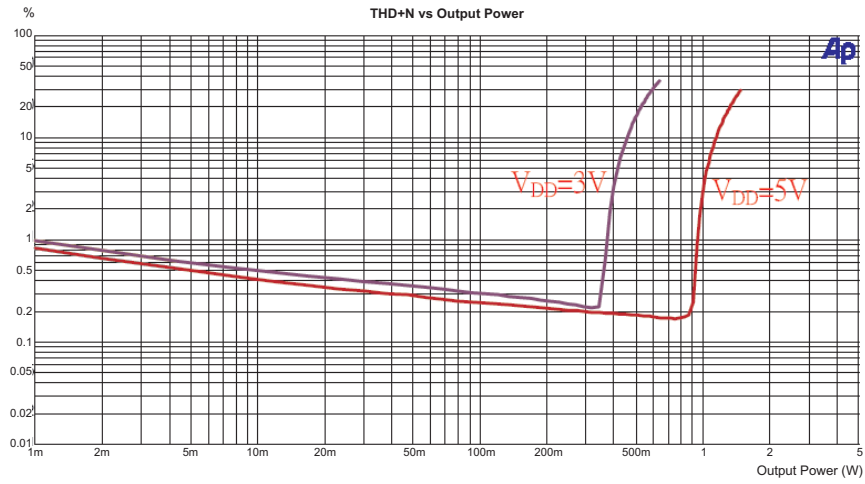

- $R_{LOAD}=16\Omega$, $V_{IN}=1\text{kHz}$ sinewave

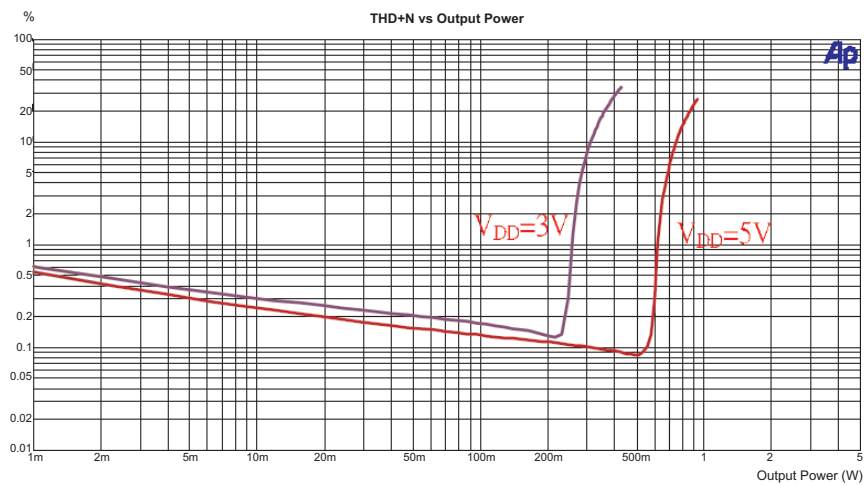

Application Circuits

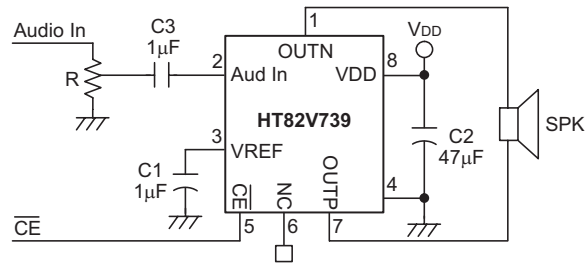

Package Information

8-pin DIP (300mil) Outline Dimensions

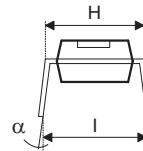
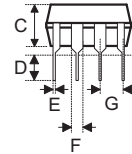
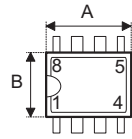

Symbol	Dimensions in mil		
	Min.	Nom.	Max.
A	355	—	375
B	240	—	260
C	125	—	135
D	125	—	145
E	16	—	20
F	50	—	70
G	—	100	—
H	295	—	315
I	335	—	375
α	0°	—	15°

8-pin SOP (150mil) Outline Dimensions

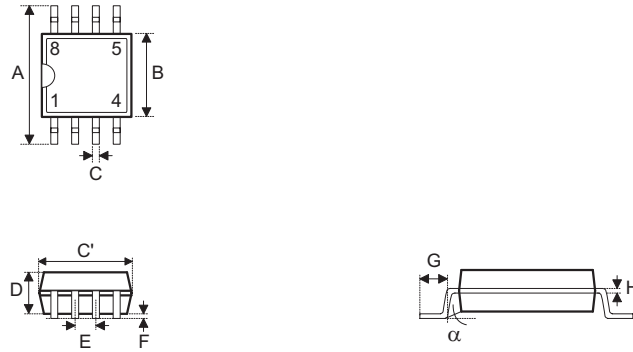

Symbol	Dimensions in mil		
	Min.	Nom.	Max.
A	228	—	244
B	149	—	157
C	14	—	20
C'	189	—	197
D	53	—	69
E	—	50	—
F	4	—	10
G	22	—	28
H	4	—	12
α	0°	—	10°

Product Tape and Reel Specifications

Reel Dimensions

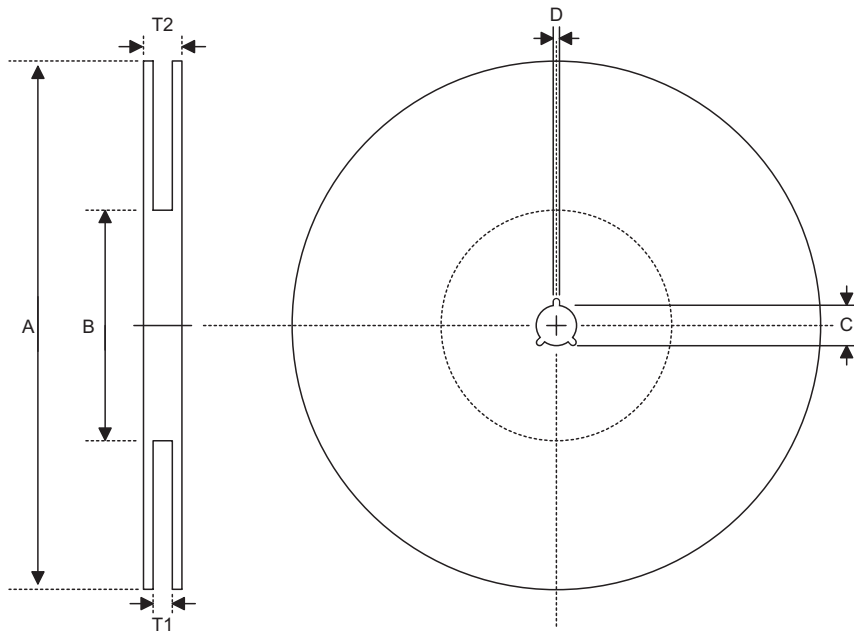

SOP 8N

Symbol	Description	Dimensions in mm
A	Reel Outer Diameter	330±1.0
B	Reel Inner Diameter	62±1.5
C	Spindle Hole Diameter	13.0+0.5 -0.2
D	Key Slit Width	2.0±0.15
T1	Space Between Flange	12.8+0.3 -0.2
T2	Reel Thickness	18.2±0.2

Carrier Tape Dimensions

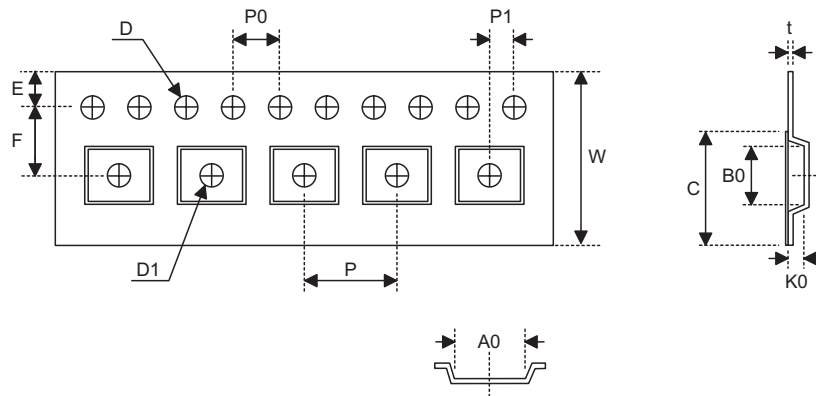

SOP 8N

Symbol	Description	Dimensions in mm
W	Carrier Tape Width	12.0+0.3 -0.1
P	Cavity Pitch	8.0±0.1
E	Perforation Position	1.75±0.1
F	Cavity to Perforation (Width Direction)	5.5±0.1
D	Perforation Diameter	1.55±0.1
D1	Cavity Hole Diameter	1.5+0.25
P0	Perforation Pitch	4.0±0.1
P1	Cavity to Perforation (Length Direction)	2.0±0.1
A0	Cavity Length	6.4±0.1
B0	Cavity Width	5.20±0.1
K0	Cavity Depth	2.1±0.1
t	Carrier Tape Thickness	0.3±0.05
C	Cover Tape Width	9.3

Holtek Semiconductor Inc. (Headquarters)

No.3, Creation Rd. II, Science Park, Hsinchu, Taiwan
Tel: 886-3-563-1999
Fax: 886-3-563-1189
<http://www.holtek.com.tw>

Holtek Semiconductor Inc. (Taipei Sales Office)

4F-2, No. 3-2, YuanQu St., Nankang Software Park, Taipei 115, Taiwan
Tel: 886-2-2655-7070
Fax: 886-2-2655-7373
Fax: 886-2-2655-7383 (International sales hotline)

Holtek Semiconductor Inc. (Shanghai Sales Office)

7th Floor, Building 2, No.889, Yi Shan Rd., Shanghai, China 200233
Tel: 86-21-6485-5560
Fax: 86-21-6485-0313
<http://www.holtek.com.cn>

Holtek Semiconductor Inc. (Shenzhen Sales Office)

5/F, Unit A, Productivity Building, Cross of Science M 3rd Road and Gaoxin M 2nd Road, Science Park, Nanshan District, Shenzhen, China 518057
Tel: 86-755-8616-9908, 86-755-8616-9308
Fax: 86-755-8616-9722

Holtek Semiconductor Inc. (Beijing Sales Office)

Suite 1721, Jinyu Tower, A129 West Xuan Wu Men Street, Xicheng District, Beijing, China 100031
Tel: 86-10-6641-0030, 86-10-6641-7751, 86-10-6641-7752
Fax: 86-10-6641-0125

Holtek Semiconductor Inc. (Chengdu Sales Office)

709, Building 3, Champagne Plaza, No.97 Dongda Street, Chengdu, Sichuan, China 610016
Tel: 86-28-6653-6590
Fax: 86-28-6653-6591

Holtek Semiconductor (USA), Inc. (North America Sales Office)

46729 Fremont Blvd., Fremont, CA 94538
Tel: 1-510-252-9880
Fax: 1-510-252-9885
<http://www.holtek.com>

Copyright © 2008 by HOLTEK SEMICONDUCTOR INC.

The information appearing in this Data Sheet is believed to be accurate at the time of publication. However, Holtek assumes no responsibility arising from the use of the specifications described. The applications mentioned herein are used solely for the purpose of illustration and Holtek makes no warranty or representation that such applications will be suitable without further modification, nor recommends the use of its products for application that may present a risk to human life due to malfunction or otherwise. Holtek's products are not authorized for use as critical components in life support devices or systems. Holtek reserves the right to alter its products without prior notification. For the most up-to-date information, please visit our web site at <http://www.holtek.com.tw>.